

For **Mardome Trade**  
on to Sloping Kerb  
See **Page 2** overleaf

### Fixing Quantities

Length of Nominal Dome Side (mm)	Number of fixings per side
600, 750	2
900, 1050, 1200	3
1350, 1500	4
1800	5
2400	7

(All fixings supplied in packs of 5.)

### Installation Instructions

**a** Install roof covering to cover existing upstand in accordance with manufacturer's installation recommendations.

**Ⓜ N.B.** It is important that there should be no excessive build up of layers, the top surface should be level and free from any protrusions or projections which may prevent adequate weather proofing.

For Unvented option, go to **d**.

**b** Mastic/Silicone around the edge of the upstand opening and correctly place vented kerb, ensuring it is located squarely to the upstand.

**c** For *Ventilated Version*: Fix vented kerb to the existing upstand using the 125mm vented kerb fastener.

**d** Carefully remove dome from its packaging and place squarely on top of the completed upstand/secured vented kerb.

**⚠ ONLY** use the fixings supplied!

**⚠ DO NOT** over drive fasteners!

**e** Fix the dome to the vented kerb or existing upstand.

For *single/double* skin dome, use 35mm dome fastener with fastener button and foam washer. For *triple* skin dome and *other variants*, use 75mm dome fastener through pre-fitted spigot.

The Dome is fully secured to the vented kerb/builders upstand as soon as fastener buttons are gripped to the dome and do not spin by hand.

**f** Fit fastener caps to each fastener button, ensuring that the key-way is aligned as shown below.

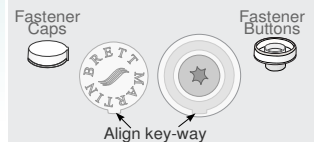

## Mardome Contents

**i** Please unpack and check that all correct parts are included and undamaged.

All **Mardome Trade** (Unvented or Vented)

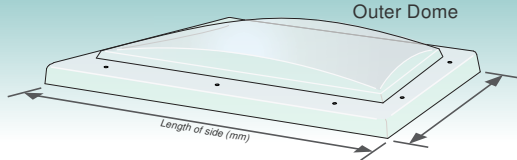

Plus, for Ventilated Version Only

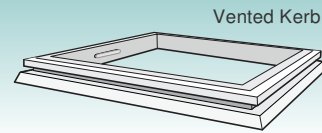

With this assembly, you will receive:  
**Dome Fixings**

**Single/Double Skin**

**OR**

**Triple Skin and other variants**

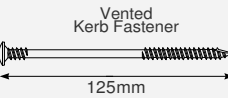
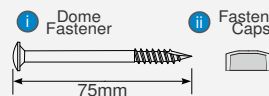
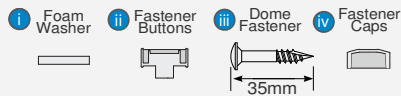

## Mardome Installation

**⚠ Please** note that all *Health and Safety Regulations* must be followed on site throughout the installation process.

**Unvented dome on to existing upstand**

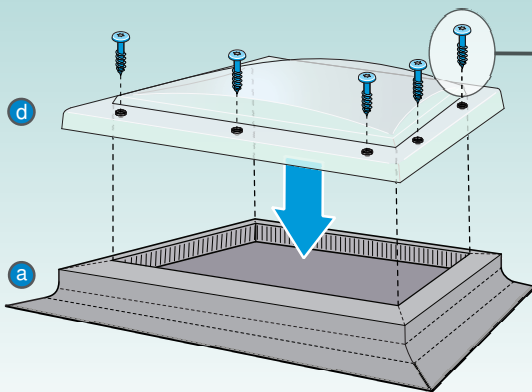

**Vented dome on to existing upstand**

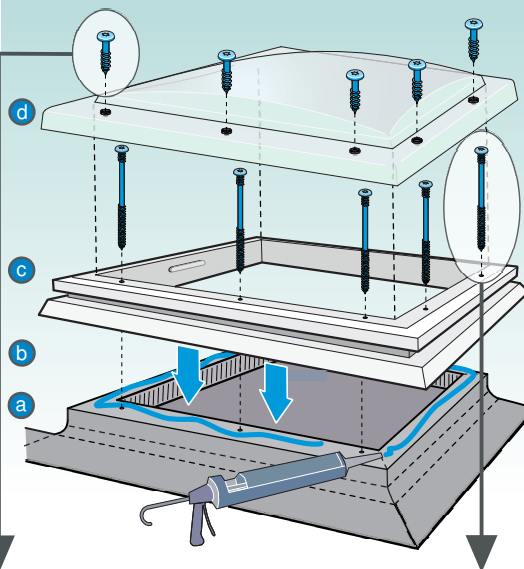

## Dome Installation Details

**i** Please select the relevant detail below for fixing:

### Kerb Fixing

**e f** For *Single/Double Skin Dome*

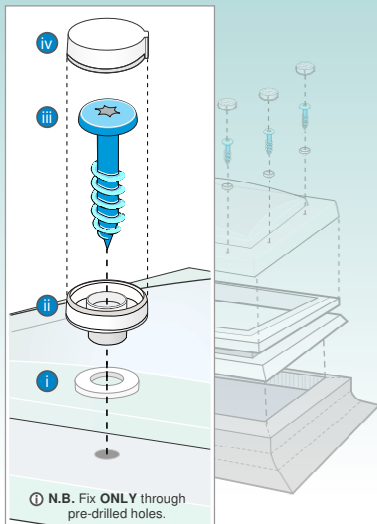

**e f** For *Triple Skin Dome and other variants*

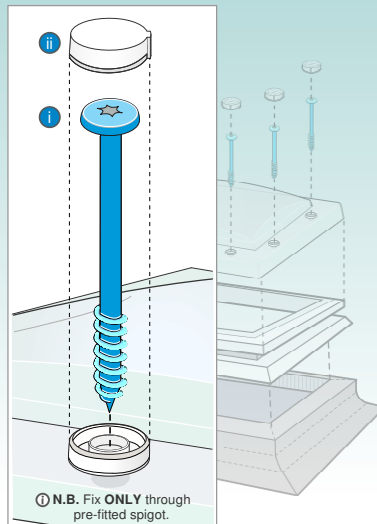

**c** *Ventilated Version Only*

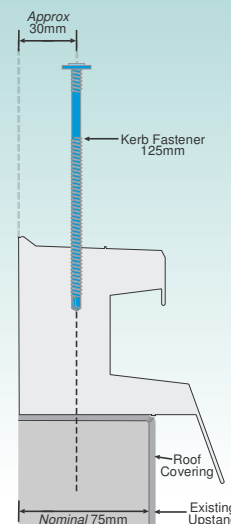

**Ⓜ TECHNICAL SUPPORT:** For any technical information/queries please contact your supplier.

**Mardome Contents**

**i** Please unpack and check that all correct parts are included and undamaged.

All Mardome Trade (Unvented or Vented)

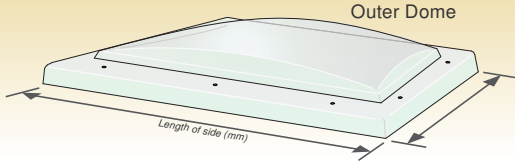

All Mardome Trade (Unvented or Vented)

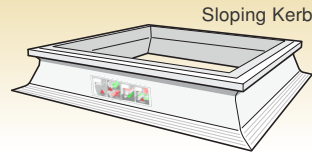

For Mardome Trade on to Existing Upstand See Page 1 overleaf

**Fixing Quantities**

Length of Nominal Dome Side (mm)	Number of fixings per side
600, 750	2
900, 1050, 1200	3
1350, 1500	4
1800	5
2400	7

(All fixings supplied in packs of 5.)

With this assembly, you will receive:  
**Dome Fixings**

**Single/Double Skin**

**OR**

**Triple Skin and other variants**

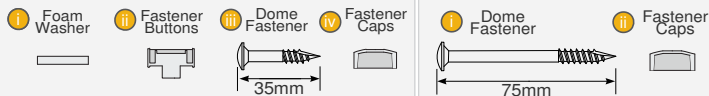

With this assembly, you will receive:  
**Kerb Fixing**

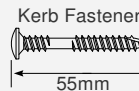

**Mardome Installation**

**⚠** Please note that all Health and Safety Regulations must be followed on site throughout the installation process.

Unvented or Vented dome on to sloping kerb

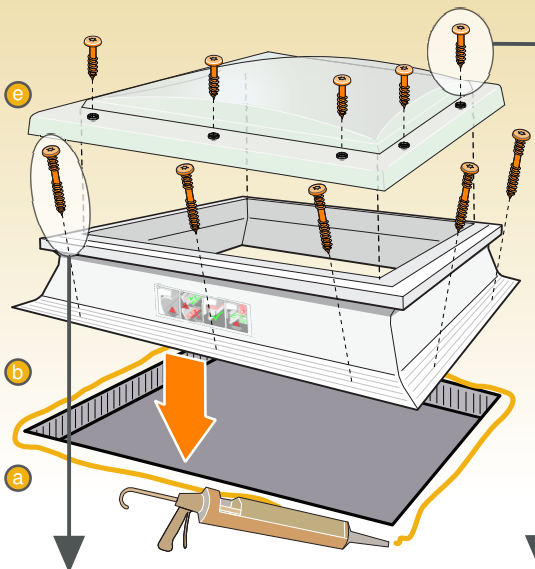

**c** Roof Covering Installation

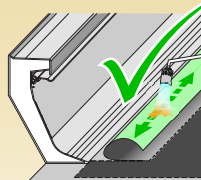

If required, lightly torch roof covering.



**WARNING:**  
Never apply direct heat or naked flame to the roof light!

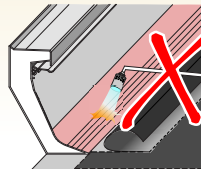

**d** **IMPORTANT:**  
Membrane Clamp Locking



Push along line as shown to lock. **DO NOT** push on soft area!

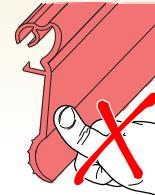

**Installation Instructions**

- a** Mastic/Silicone around the edge of the roof opening and correctly position the sloping kerb, ensuring it is located squarely over the roof opening.
- b** Fix sloping kerb to the roof using the 55mm kerb fastener.  
  
See above **Fixing Quantities** table for the correct quantity of fastenings required for the size of the dome.  
  
**i** **N.B.** Length of side refers to the nominal dome size (equivalent to inside base of kerb foot).
- c** Install roof covering up to lip, to stop under membrane clamp. Install in accordance with manufacturer's installation recommendations.  
  
**i** **N.B.** Never apply direct heat or naked flame to the rooflight! Ensure the roof covering **does not** foul clamp!
- d** Lock the membrane clamp down fully, as shown.
- e** Carefully remove dome from its packaging and place squarely on top of the secured sloping kerb.

**Kerb Fixing**

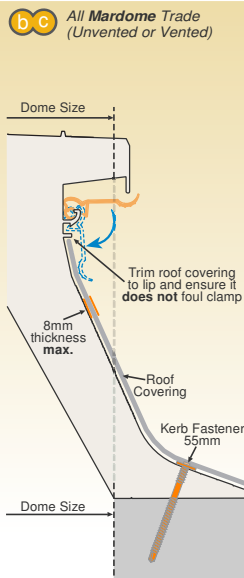

**Dome Installation Details**

**i** Please select the relevant detail below for fixing:

**f g** For **Single/Double Skin Dome**

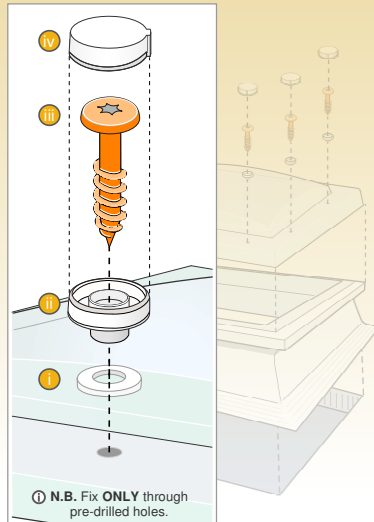

**i** **N.B.** Fix **ONLY** through pre-drilled holes.

**f g** For **Triple Skin Dome and other variants**

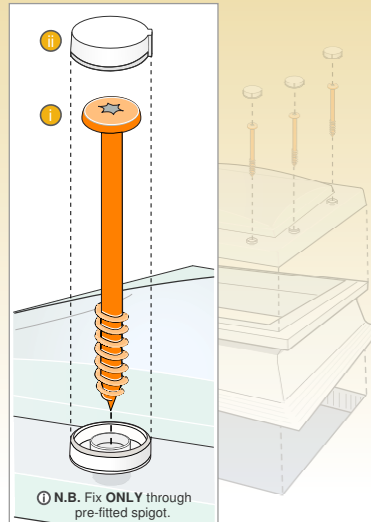

**i** **N.B.** Fix **ONLY** through pre-fitted spigot.

**⚠** **ONLY** use the fixings supplied!

**⚠** **DO NOT** over drive fasteners!

**f** Fix the dome to the sloping kerb.

For **single/double** skin dome, use 35mm dome fastener with fastener button and foam washer. For **triple** skin dome and **other variants**, use 75mm dome fastener through pre-fitted spigot.

The Dome is fully secured to the sloping kerb as soon as fastener buttons are gripped to the dome and do not spin by hand.

**g** Fit fastener caps to each fastener button, ensuring that the key-way is aligned, as shown.



**ⓘ TECHNICAL SUPPORT:** For any technical information/queries please contact your supplier.